



FLUSHMATE® INTELLI-Flush™

AUTOMATIC FLUSHING SYSTEM

Installation Instructions
MODEL# K-100

Scan FLUSHMATE • 30075 Research Drive • New Hudson, MI 48165
Phone: (248) 446-5300, 800-533-3450, www.flushmate.com

COMPONENTS

Tools Required: Philips and slotted screwdriver, pliers, ruler and 1-3/4" hole saw for In-Wall

- A) Flush Module
- B) Battery Pack
- C) Battery Holder
- D) Over-Ride Button
- E) Cover Key
- F) T-Wrench/Depth Gauge/
Sensor Tool
- G) Screws & Anchors (2)
- H) C-cell Alkaline Batteries (4)
- I) AA-cell Alkaline Batteries (4)
- J) On-Wall Sensor
- K) In-Wall Sensor
- L) Adapter 504
- M) Adapter 501-B
- N) Mounting Screws (8)

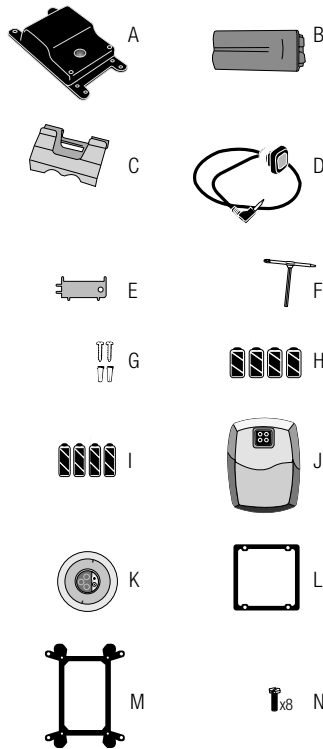

The Sensor and Flush Module contained within this kit have been programmed to work together and should not be switched with similar components from other kits.

STEP #1

- 1) Remove retainer clips, (image 1), flush rod, (image 2), and handle, (image 3). (Note: reverse threads on handle.)

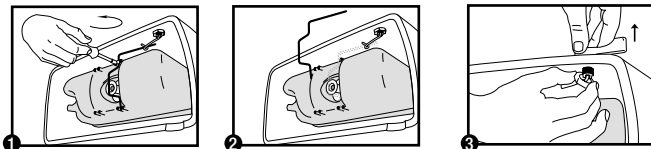

STEP #2

- 1) Install Over-Ride Button (D), (image 4). Identify appropriate Adapter (L or M) if needed, (image 5).

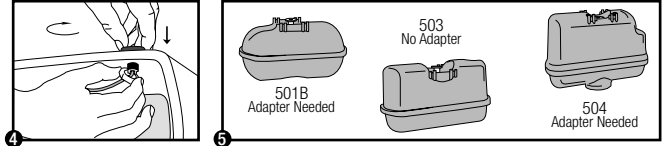

- 2) Place Flush Module (A) in position over Actuator (image 6). (Actuator is the centered white disk with Philip screw in center.) If using Adapter, (image 7) note the positioning of the Flush Module (A) wire, (image 6 & 7).
- 3) Insert T-wrench/Depth Gauge/Sensor tool (F) in hole of Flush Module (A), (image 8). Adjust Actuator by loosening set screw and turning Actuator to proper height according to depth gauge, so that yellow ring on depth gauge aligns with top of Flush Module (A), (image 9). Tighten set screw on Actuator.
- 4) Attach the Flush Module (A) with (4) screws, (image 10). For the 501-B Adapter (M), (8) screws are required.

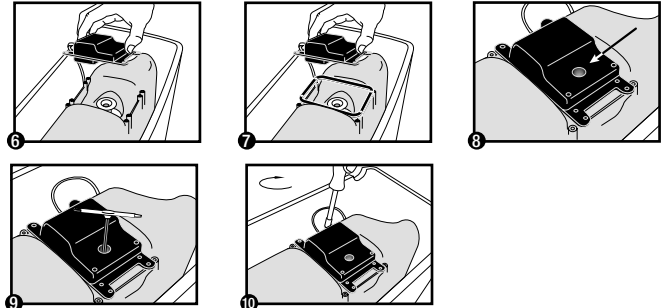

STEP #3

- 1) Plug Over-Ride Button (D) wire into Flush Module (A), (image 11)
- 2) Remove cover on Battery Pack (B), (image 12). Install batteries, (image 13), noting the battery polarity (+/-) printed on pack. Reinstall cover on Battery Pack (B), (image 14). Place Battery Pack (B) in Battery Holder (C), (image 15). Hang Battery Holder (C) on top edge of china tank and connect the Flush Module (A) wire into the Battery Pack (B). Slide rubber boot over connection, (image 16). (Using the Battery Holder (C) is optional. If there is ample space, you can place it anywhere in the tank as long as the wire is not being stretched.)

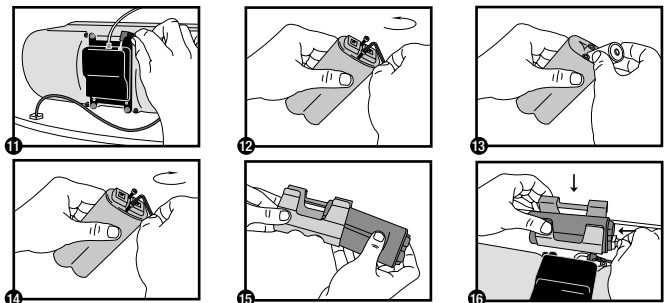

STEP #4 Sensor Mounting (select proper instructions based on sensor type)

In-Wall Sensor (Requires the use of 1-3/4" hole saw bit.)

- 1) Determine hole location, check for obstructions behind the wall, including wall studs, (image 17). After marking location, drill 1-3/4" hole with hole saw into wall. **IMPORTANT:** Center sensor **eye** 2-1/2" above seat in up position (image 23).
- 2) Unscrew cover using cover key (E) and remove sensor from housing, (image 18).
- 3) Insert and fasten the sensor housing so that the orientation of the mounting screws are horizontal, (images 19 & 20). Insert (4) AA batteries into sensor and reinstall sensor into housing. Reattach the cover, (image 21). To adjust sensor range see Step #5.

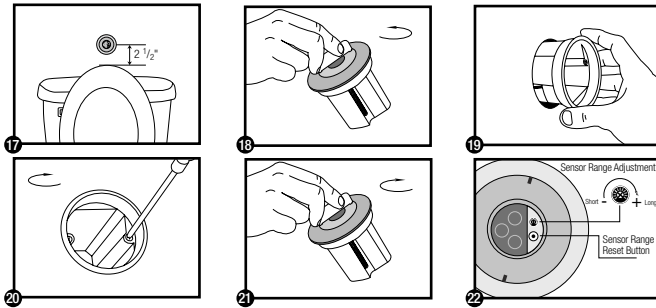

On-Wall Sensor

- 1) Center sensor eye 2-1/2" above the seat in up position, (image 23). Attach to wall using adhesive strip and/or screws & anchors (G). Note the orientation of the sensor, (image 23). **WARNING:** Adhesive strip can only be applied once; once installed it is difficult to remove.
- 2) Remove cover using key, (image 24) and install (4) AA batteries. Reattach sensor cover. To adjust sensor range see Step #5.

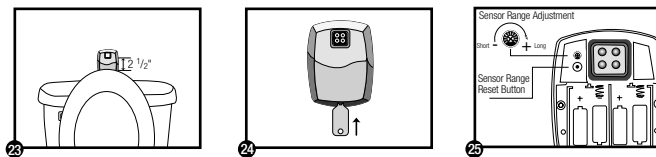

STEP #5 Test Sensor Range/Adjustment

Both sensors are factory set. Green light on sensor will flash 3 times at the start of every use. Should the sensor need adjusting:

- 1) Remove the cover using Cover Key (E), (image 18 or 24). For On-Wall sensor, remove rubber cover concealing the reset button and range adjuster screw.
- 2) Depress the sensor range reset button, (image 22 or 25). During the 7 minute start up sequence the green light flashes constantly when a user is in view.
- 3) Using the Sensor Tool (F), turn the sensor range adjustment screw, (image 22 or 25) counter-clock wise, shortening the sensor range, until the green light stops flashing while you are standing at the front rim of the bowl. Slowly turn the sensor range adjustment screw clock-wise until the green light flashes while standing at the front of the bowl.
- 4) Reinstall rubber cover for On-Wall sensor and re-attach the cover.

TROUBLESHOOTING

PROBLEM	CAUSE	SOLUTION TO PROBLEM
Green L.E.D. (light) flashes 3 times when there are no users.	Front of Object Lock Sensor is covered or Object Lock Sensor is set too far out, registering unwanted object.	Remove item covering sensor or adjust Object Lock Sensor activation distance. (See image 21 or 24 - Adjust Sensor Range)
Yellow L.E.D. (light) flashes.	Batteries need replacing.	Replace batteries. Use Only Alkaline Batteries.

OBJECT LOCK SENSOR - Detects user or object.

BATTERY L.E.D. - Yellow light flashes indicating it is time to replace the batteries.

USER-IN-VIEW L.E.D. - Green light flashes 3 times, after 5 second delay, when a user is in view. The green light flashes constantly when a user is in view during the 7 minute start up sequence.

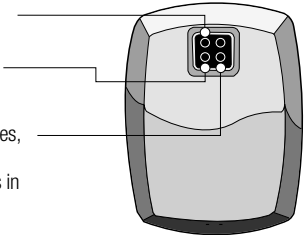

Date Installed: _____

Style: On-Wall In-Wall **Trim:** White Chrome

Please keep tools accessible for future use. For additional information visit: <http://www.flushmate.com>.

This device complies with Part 15 of the FCC Rules. Operation is subject to the following two conditions: (1) this device may not cause harmful interference; and (2) this device must accept any interference received, including interference that may cause undesired operation.
FCC ID: RNV0009919150

ATTENTION OWNER: THESE ARE THE TERMS OF YOUR WARRANTY

Sloan **FLUSHMATE**® (the "Company") warrants the INTELLI-FLUSH® Automatic Flushing System (the "unit") to be free of defects in material and workmanship for a period of three (3) years from the date of purchase and the Company promises to provide a replacement for any part of this product that proves, upon our inspection and within three years from date of purchase, to be defective in material or workmanship. All labor and transportation costs or charges incidental to warranty service are to be borne by the purchaser-user. This warranty does not cover the life of the batteries and is subject to the following:

Specific Conditions to Warranty

1. A Warranty Registration card has been fully completed and mailed by the purchaser (the "user") to the Company within thirty (30) days of the date of purchase. Product may also be registered online at www.flushmate.com or by calling 800-533-3460.
2. The unit has been subject to proper installation, operation and maintenance as outlined in the installation instructions that were supplied with the unit. Note carefully that this warranty is voided if the unit is installed on anything other than 501-B, 503, 504, or later Series **FLUSHMATE**® systems.
3. Service and repairs may only be performed by authorized representatives of the Company or by others upon specific approval by the Company. Unauthorized repairs or alterations shall specifically void the warranty.
4. USE OF PETROLEUM-BASED LUBRICANTS OR CORROSIVE CLEANING PRODUCTS CONTAINING CHLORINE, SUCH AS HOUSEHOLD BLEACH, DROP-IN BLOCKS OR TABLETS, OR DISINFECTANTS THAT ARE APPLIED INSIDE THE CHINA HOLDING TANK WILL VOID YOUR INTELLI-FLUSH® WARRANTY.
5. PROOF OF PURCHASE IS REQUIRED.

Exclusions

IN NO EVENT SHALL THE COMPANY BE LIABLE FOR INCIDENTAL OR CONSEQUENTIAL DAMAGES, FOR DAMAGES RESULTING FROM IMPROPER INSTALLATION, OR FOR DAMAGES CAUSED BY NEGLIGENCE, ABUSE OR ALTERATION. ALL IMPLIED WARRANTIES, INCLUDING ANY IMPLIED WARRANTY OF MERCHANTABILITY OR FITNESS FOR ANY PARTICULAR PURPOSE ARE LIMITED TO A PERIOD OF THREE (3) YEARS FROM DATE OF PURCHASE.

Some states do not allow limitations on the duration of an implied warranty and some states do not allow exclusions or limitations regarding incidental or consequential damages so the above limitations may not apply to you. This warranty gives you specific legal rights and you may have other rights which vary from state to state. No person is authorized to change, add to, or create any warranty or obligation other than that set forth herein. To obtain warranty service, contact Consumer Services toll free (USA, CANADA, and MEXICO) 800-533-3460 or write to us at:

FLUSHMATE® A Division of Sloan Valve Company, ISO 9001 Quality System Certified, 30075 Research Drive, New Hudson, MI 48165 U.S.A., 800-533-3460, 248-446-5300, www.flushmate.com

© FLUSHMATE Division • PATENT PENDING • MADE IN TAIWAN