

19 294 2-Hole Wall Mount Vessel Trim

Exploded View

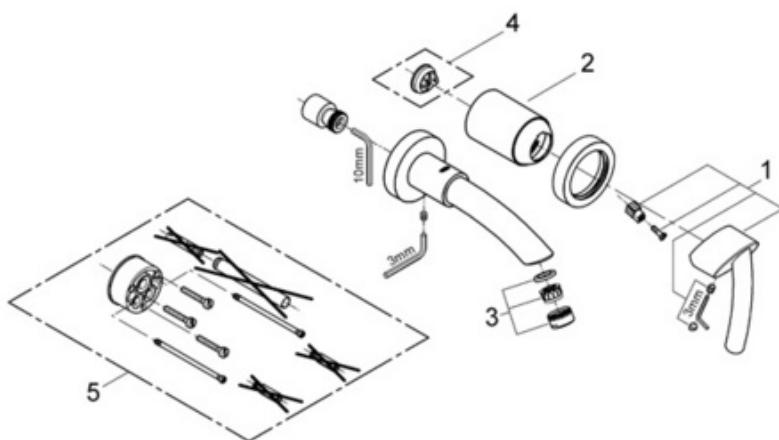

Parts Breakdown

Pos No.	Spare Part Description	Product No.	Pcs.
	19 294		
1	Lever handle	46 502	1
2	Cap	09 038	1
3	Flow regulator	13 955	1
	Special Accessories		
4	Handle rotation stop	46 375	1
5	Extension kit	46 191	1